

Artikel.-Nr. / Item No.	$\varnothing X$
1012004300	22 mm
1012004400	25 mm

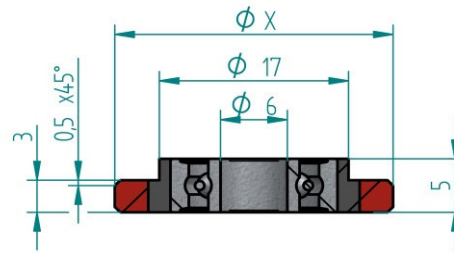

Lauffläche / Running surface : PU

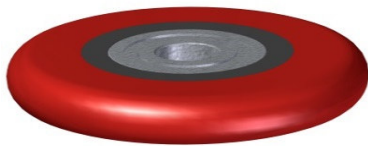

Artikel.-Nr. / Item No.	$\varnothing X$
1012004000	25 mm
1012004100	34 mm

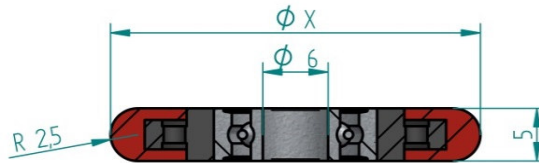

Lauffläche / Running surface : PU

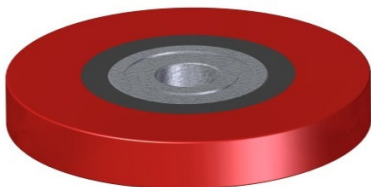

Artikel.-Nr. / Item No.	$\varnothing X$
1012003200	25 mm
1012004200	34 mm

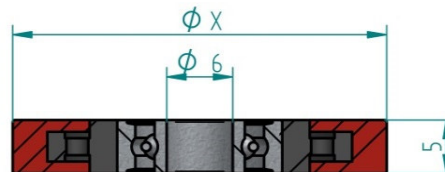

Lauffläche / Running surface : PU

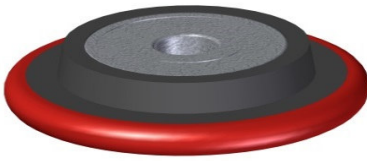

Artikel.-Nr. / Item No.	Ø X
1012003800	34 mm
1012004600	44 mm

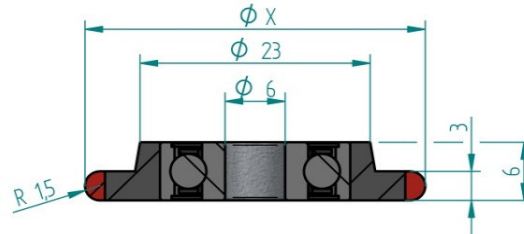

Lauffläche / Running surface : PU

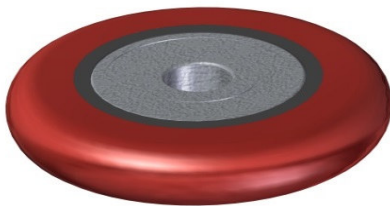

Artikel.-Nr. / Item No.	Ø X
1012000700	25 mm
1012010600	31 mm
1012010700	32 mm
1012000900	34 mm
1012014900	36 mm
1012010400	40 mm
1012001300	44 mm

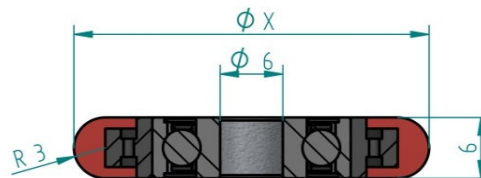

Lauffläche / Running surface : PU

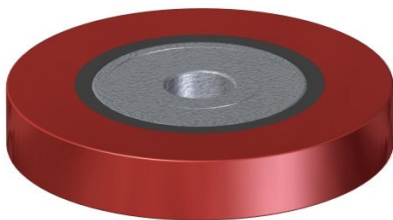

Artikel.-Nr. / Item No.	Ø X
1012000800	25 mm
1012001100	34 mm
1012001400	44 mm

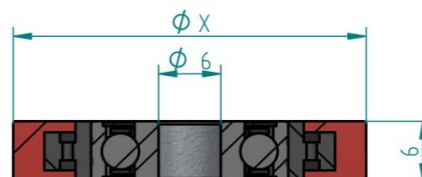

Lauffläche / Running surface : PU

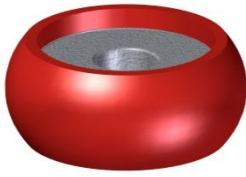

Artikel.-Nr. / Item No.	$\varnothing X$
1012004800	23 mm
1012005000	25 mm

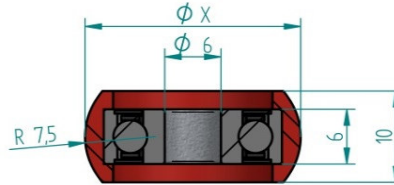

Lauffläche / Running surface : PU

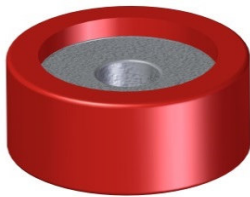

Artikel.-Nr. / Item No.	$\varnothing X$
1012004900	23 mm
1012005100	25 mm

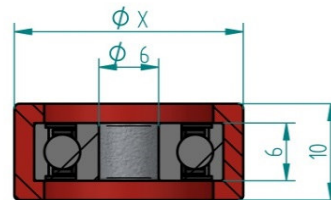

Lauffläche / Running surface : PU



Artikel.-Nr. / Item No.	$\varnothing X$
1012000100	28 mm
1012000300	34 mm
1012000500	44 mm

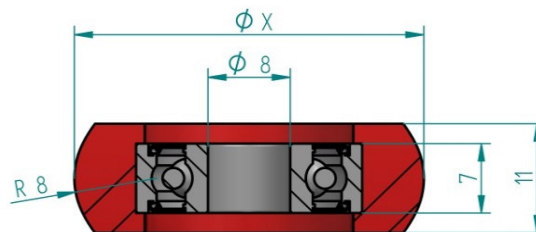

Lauffläche / Running surface : PU

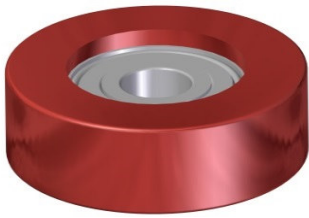

Artikel.-Nr. / Item No.	$\varnothing X$
1012000200	28 mm
1012000400	34 mm
1012000600	44 mm

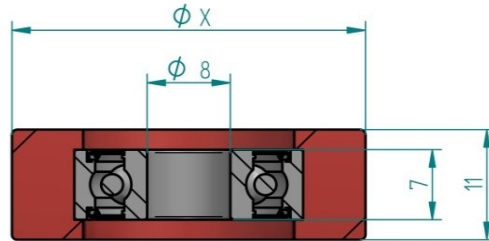

Lauffläche / Running surface : PU



Artikel.-Nr. / Item No.	$\varnothing X$
1012008500	40 mm

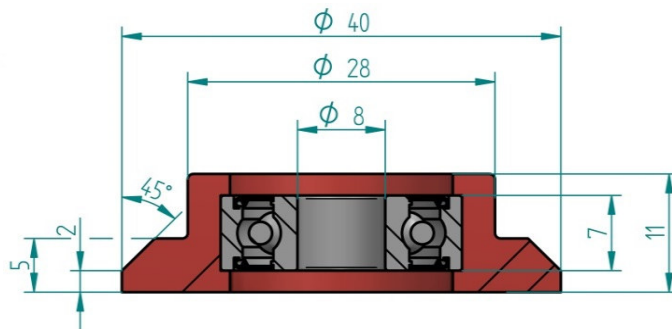

Lauffläche / Running surface : PU

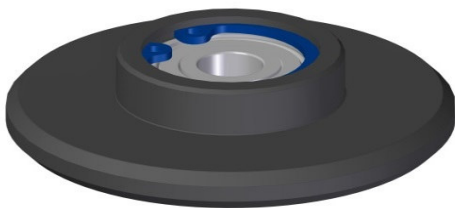

Artikel.-Nr. / Item No.	$\varnothing X$
1012006600	55 mm
1012007700	59 mm

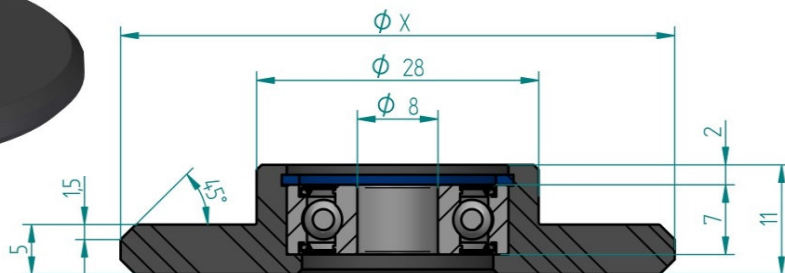

Lauffläche / Running surface : POM

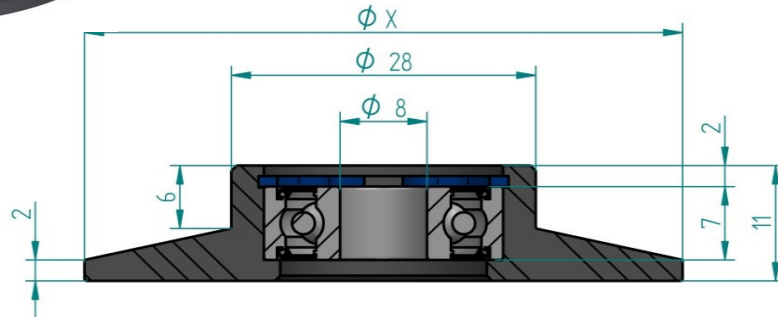
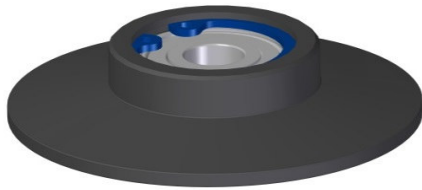

Artikel.-Nr. / Item No.	ϕX
1012014100	38 mm
1012008500	40 mm
1012006800	44 mm
1012006900	50 mm
1012006700	55 mm
1012007000	58 mm
1012007100	66 mm
1012005300	70 mm
1012009800	85 mm

Lauffläche / Running surface : POM

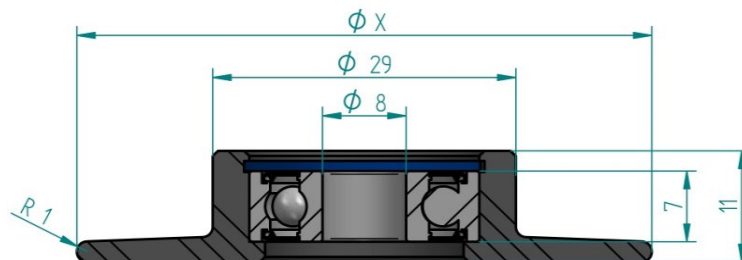
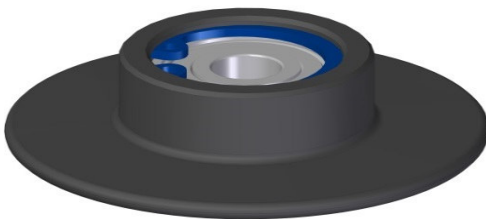

Artikel.-Nr. / Item No.	ϕX
1012014300	53 mm
1012014400	55 mm

Lauffläche / Running surface : POM